

- Do not discard packaging until product has been successfully installed.
- Components may be installed in locations other than where shown. Always verify wire harness length.
- While routing, follow factory wiring when possible.
- Use provided dielectric grease on all connections.
- Always consult labels on Harnesses when making connections.
- Avoid rotating or hot components when securing.
- Before drilling any holes, check behind area to be drilled for any interference.

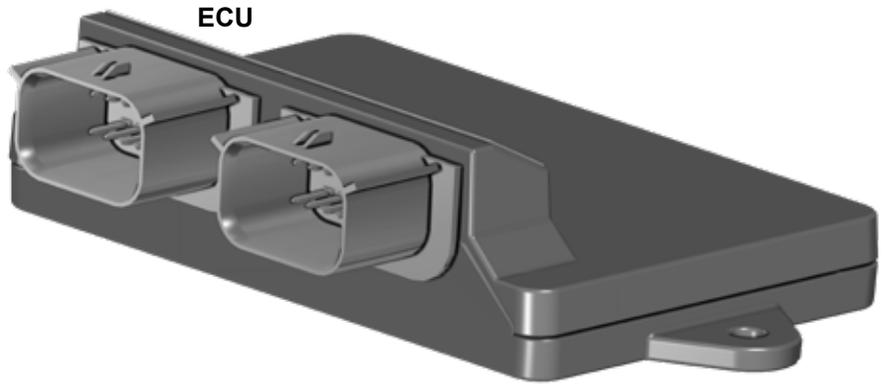

Turn Signal Switch

Hazard and Horn Switch

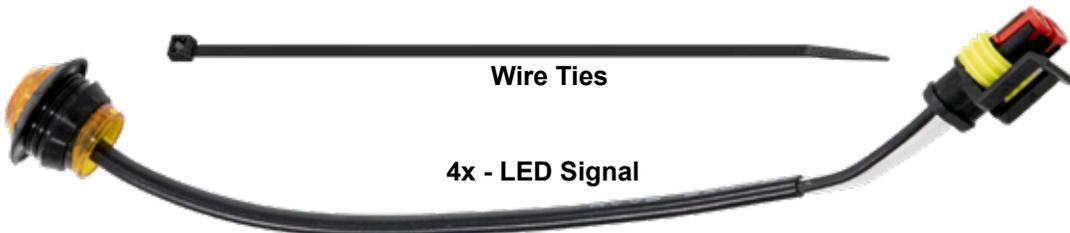

Need help with your installation?



sales@superatv.com



www.superatv.com



1-855-743-3427



8:00am - 8:00pm EST M-Th
8:00am - 7:00pm EST Friday
9:00am - 2:00pm EST Saturday

Read instructions and view illustrations before beginning.

*Thank You
For Choosing*

SUPERATV.COM[®]

to rear of machine



to Left Rear Tail Light



to Right Rear Tail Light



to License Plate Light (opt)



to Turn Signal Switch



to Horn / Hazard Switch

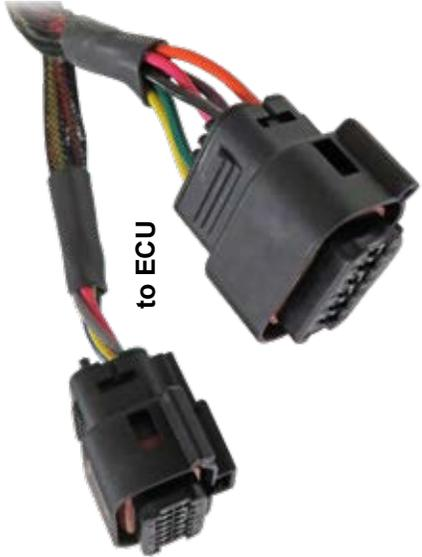

to ECU



to Horn



to LED's



green and black wires = right
yellow and black wires = left

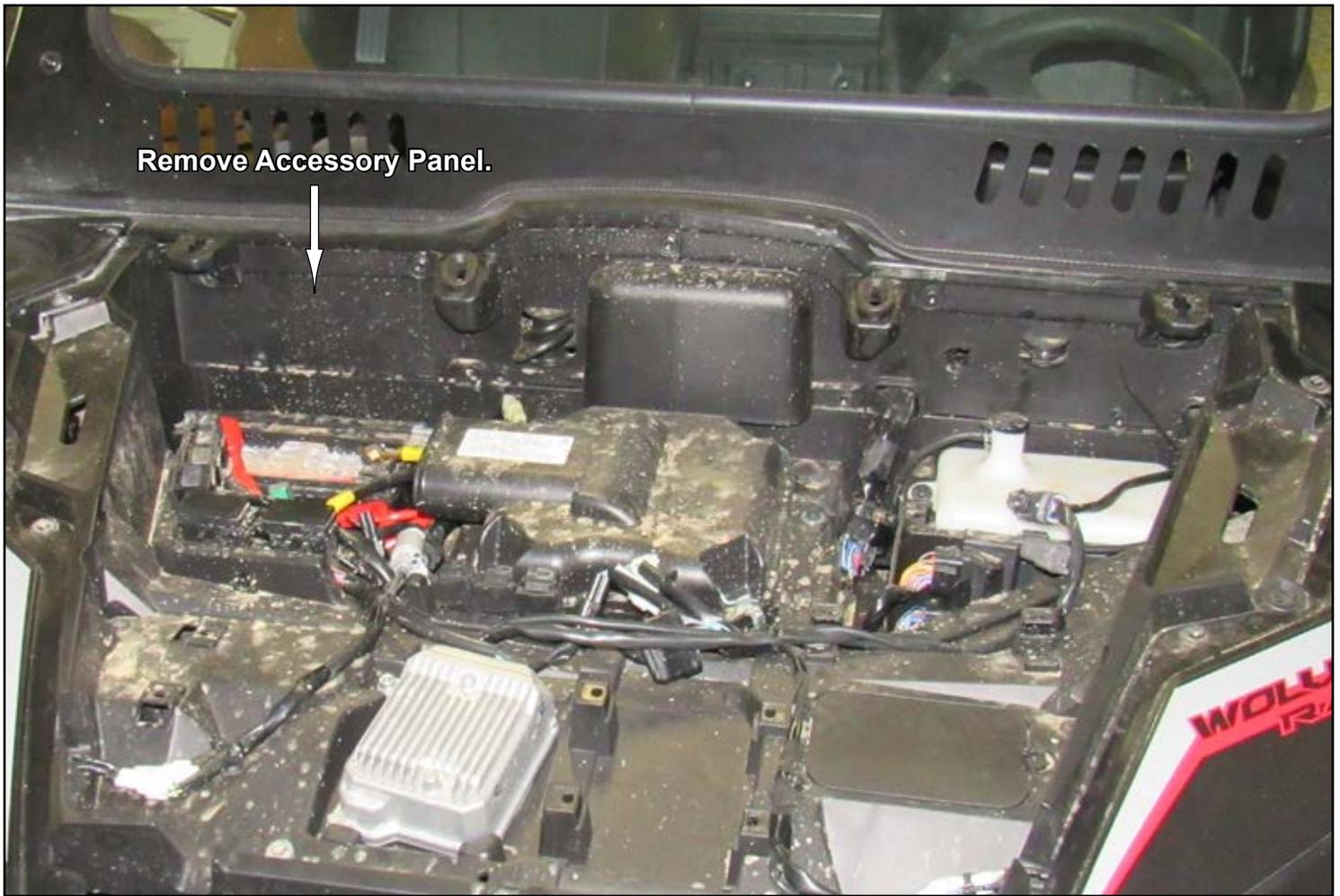

Remove Accessory Panel.

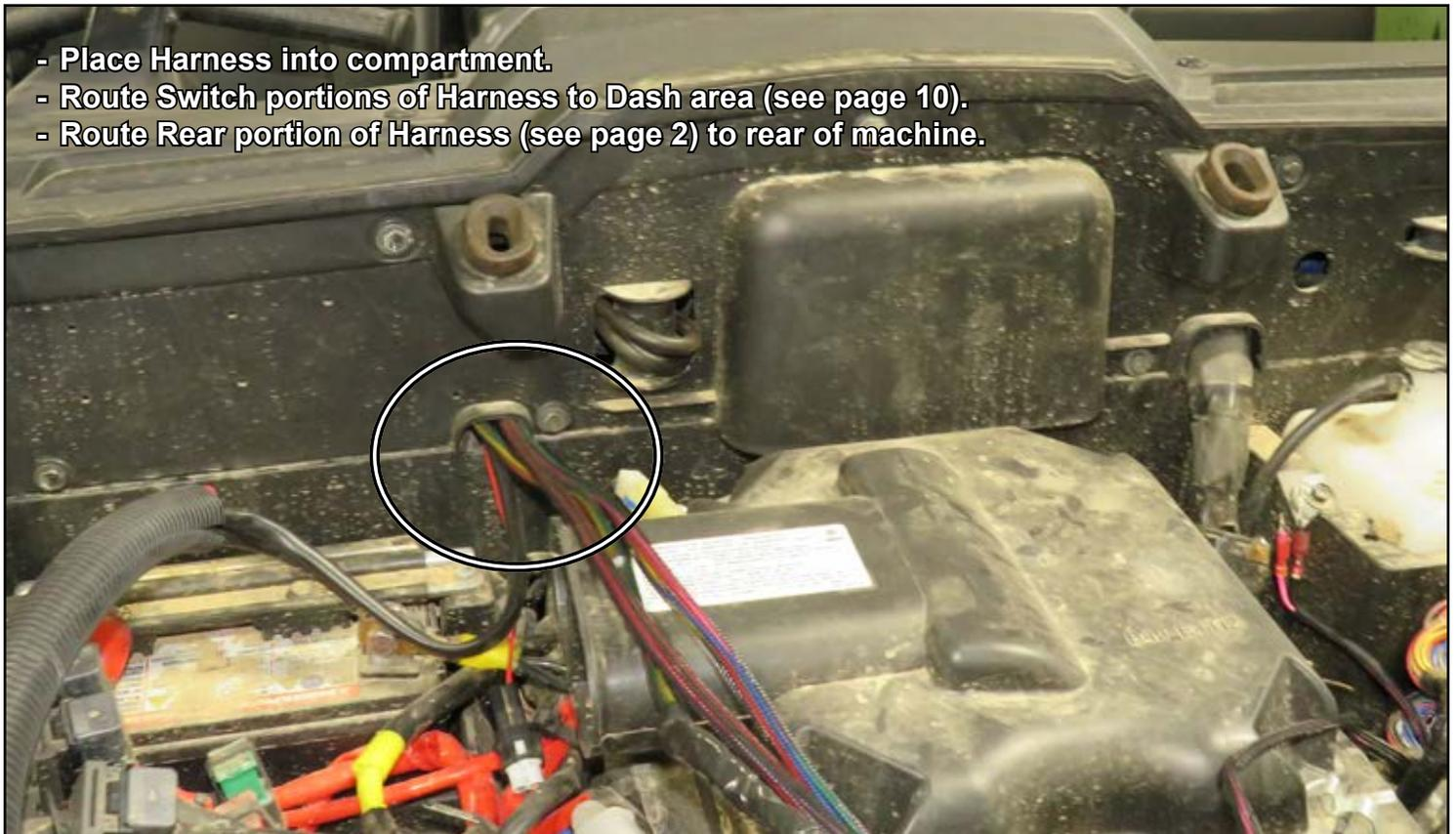

- Place Harness into compartment.
- Route Switch portions of Harness to Dash area (see page 10).
- Route Rear portion of Harness (see page 2) to rear of machine.



Reinstall Accessory Panel.

Rear

Look up and into area shown to access rear stock Harness. Driver side is same.

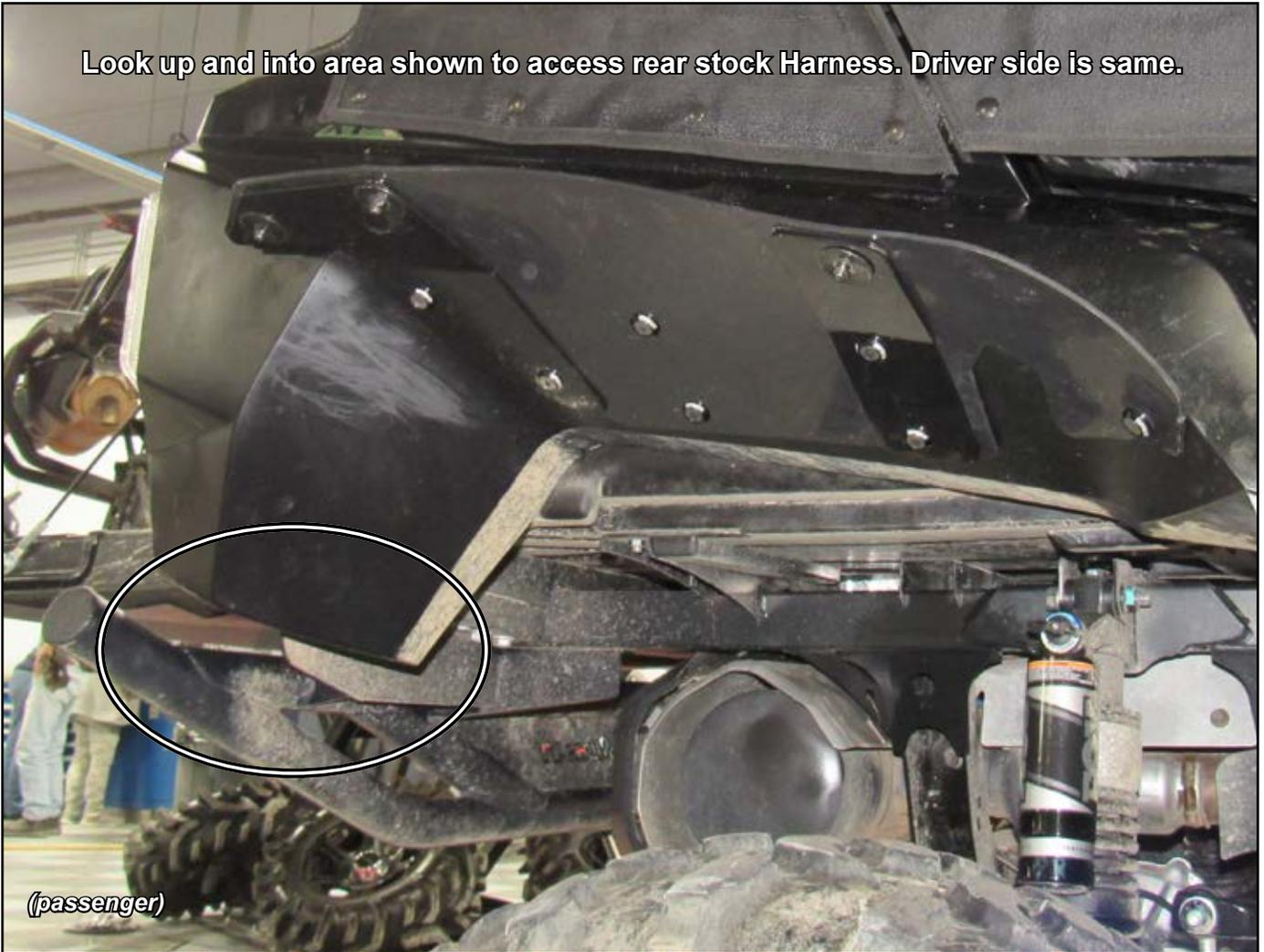

Rear continued

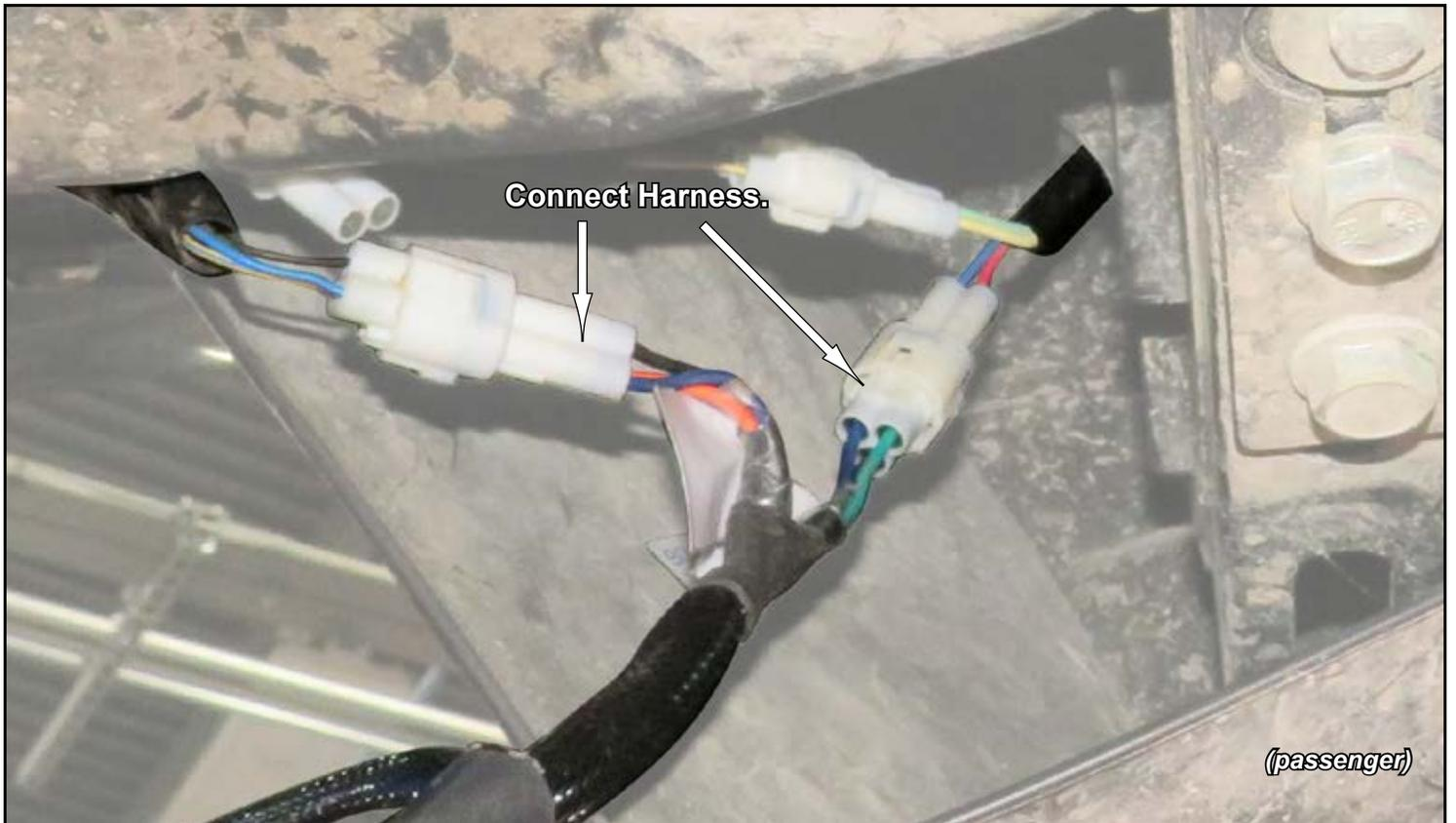

Rear continued



- Plug in Harness and secure ECU to Accessory Panel with hardware shown; tighten.
- Locate stock connector shown.

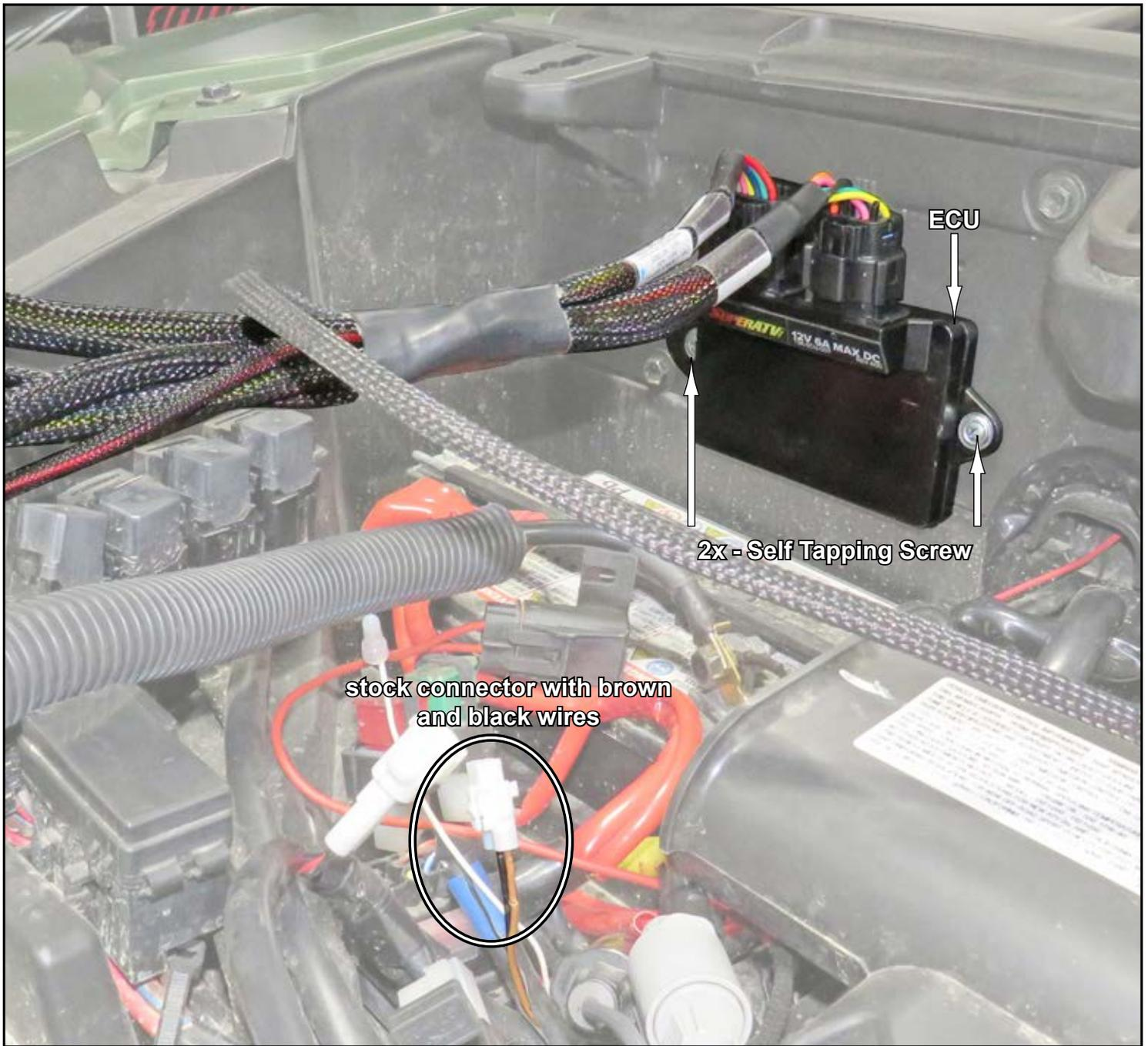

Before drilling any holes, check behind area to be drilled for any interference.

LED Signals:

- User may install in locations different than shown.
- Drill a Ø3/4" hole in body and install LED Signal. Repeat for remaining LED Signals.
- Plug LED Signals into corresponding inputs on Harness.
- Secure all Wires as needed.

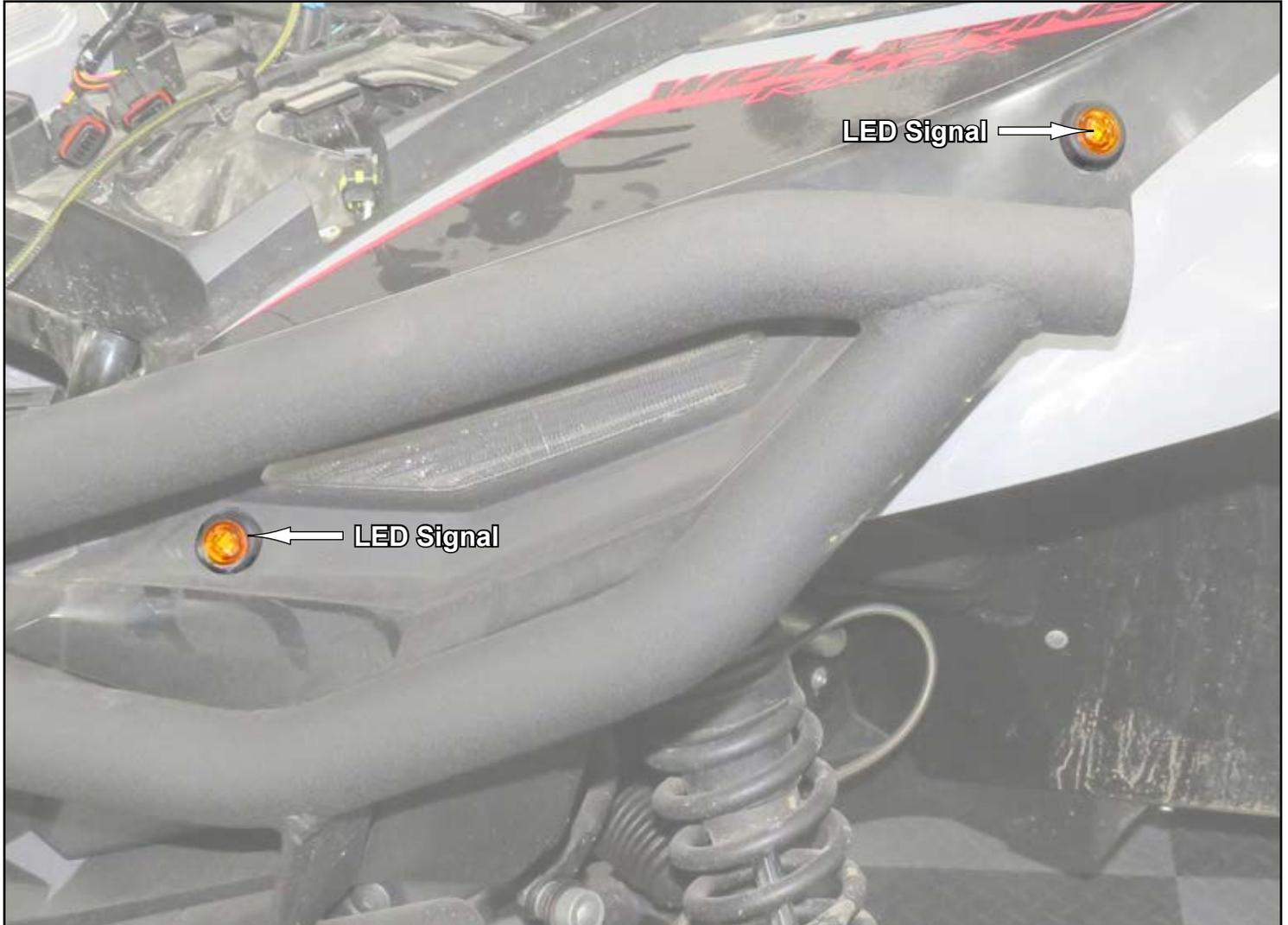

! If Light is hard to insert separate as shown.

- Separate LED from Gasket.
- Install Gasket into hole.
- Install LED into Gasket.



Horn:

- User may install Horn in location different than shown.
- Install Horn to Bracket.
- Connect Harness to Horn.
- Secure to location shown; tighten.



SuperATV recommends testing Switches before permanently mounting.



- Connect Harnesses to Switches.
- Secure Switches.



Accessory to Turn Signal Kit Wiring

Left Turn Signal Harness shown in illustrations.

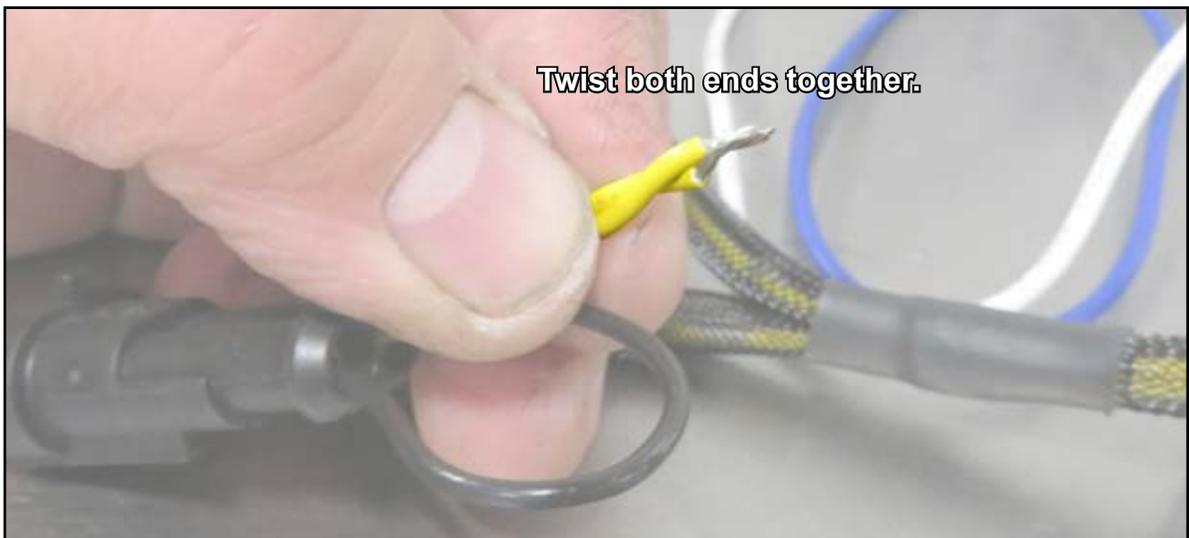
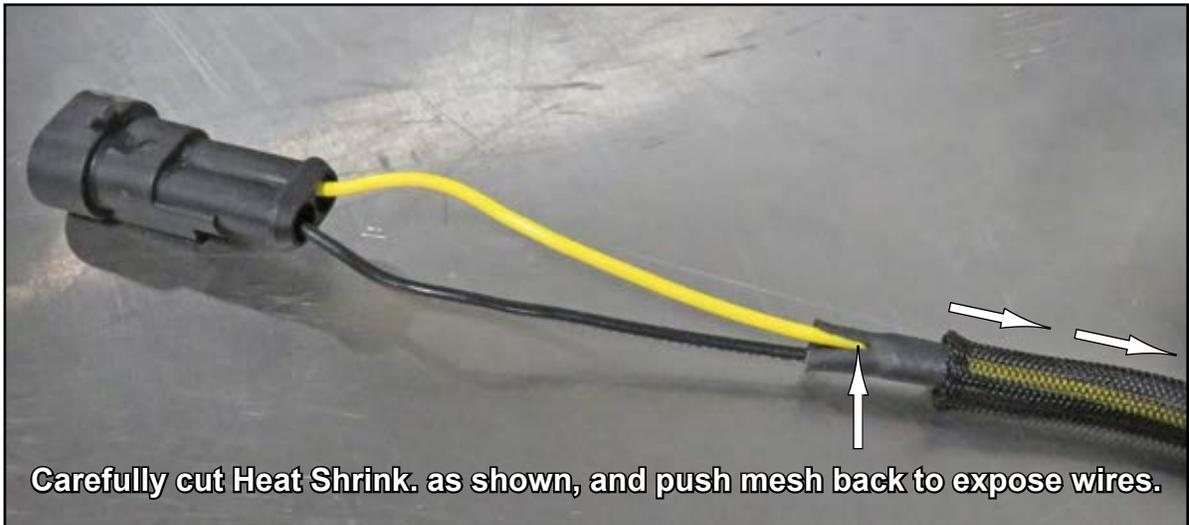

Accessory to Turn Signal Kit Wiring continued

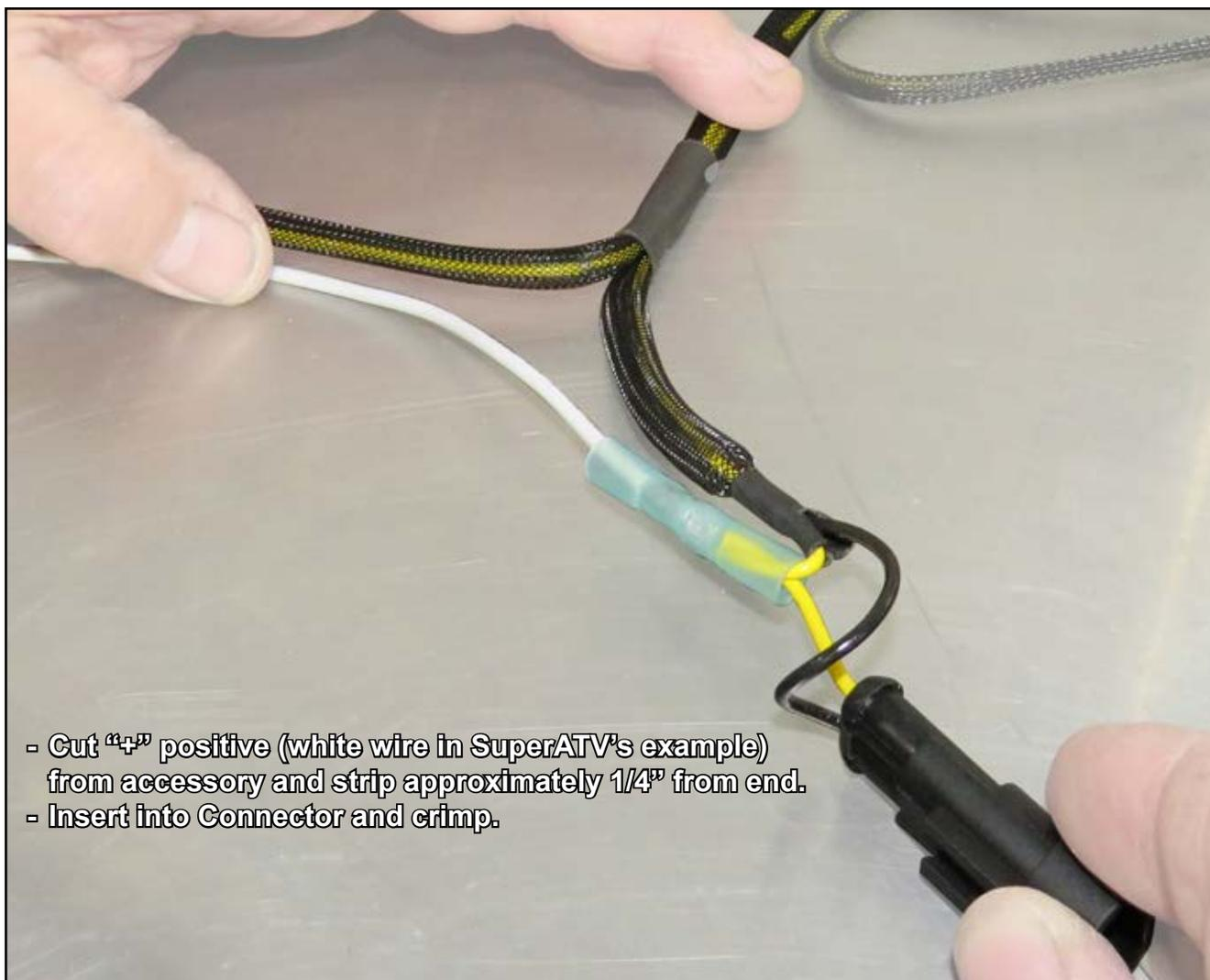
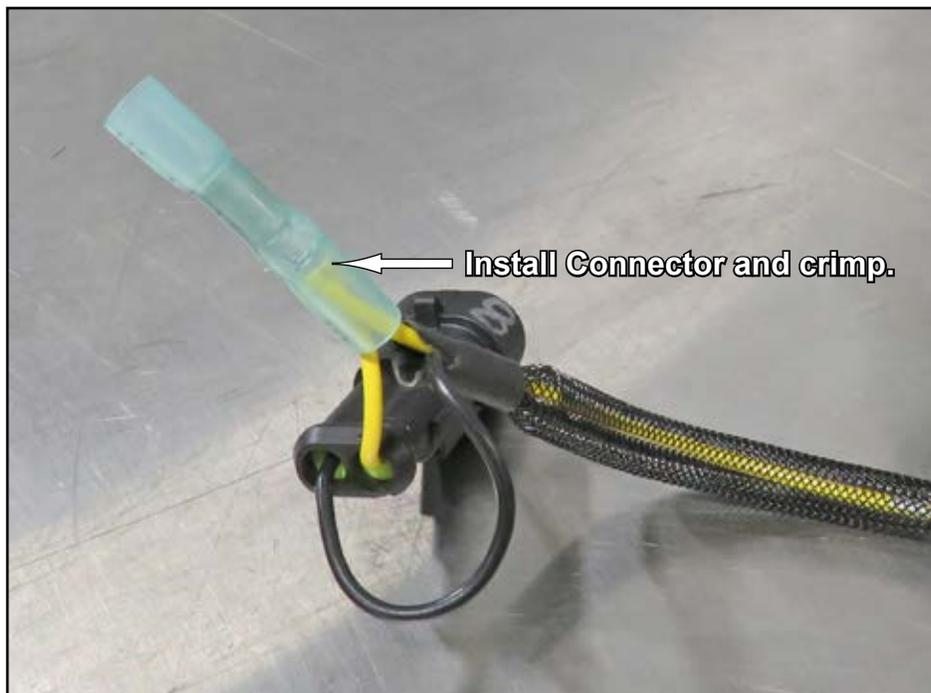

SuperATV recommends using a handheld mini torch, or lighter, to activate heat shrink on Connector.